

QUAD 33-303

service supplement

QUAD 33-303

service supplement

	<i>page</i>
Contents	
Circuit Description Quad 33	3
Circuit Description Quad 303	5
Dismantling the pushbuttons	4
Setting up the Quad 303	6
Fault location	7
Summary of pushbutton switching	8
Modifications	9
Components lists	10-14

Illustrations

	<i>Fig</i>
Dismantling the pushbuttons	1
Simplified circuit diagram Quad 303	2
Quad 33 Top chassis view	3
Disc Adaptor Board M12021	4
Disc Pre-amplifier Board M12019	5
Tape Adaptor Board M12027 under side	6 (a)
Tape Adaptor Board M12027 top side	6 (b) & (c)
Amplifier Board M12017	7 (a) & (b)
Filter Board M12029	8
Power Supply Board M12032	9
Quad 303 Underside view	10
Driver Board M12038	11 (a) & (b)
Regulator Board M12035	12

General

For ease of servicing the Quad 33 and 303 units have been divided as far as possible into the clearly defined separate blocks shown within the dotted lines in the circuit diagrams. Of these, five in the control unit are plug-in modules and three in the power amplifier are hinged to provide access to both sides. All are easily replaced if necessary (see photographs).

A brief description of the circuit will assist logical fault finding.

QUAD 33

The Disc input is fed directly into the Disc Adaptor board (M.12021) where it passes through one of four circuits (three are normally wired leaving one blank) depending on which edge is inserted into the socket. Trying another edge may help in fault location but note that some components are common to more than one edge. The signal then passes to the Pre-amplifier board (M.12019) which is used for amplifying the Disc input only.

After the Pre-amplifier board, pushbutton switching selects either the output of this board or signals from Radio inputs, into the Tr200/Tr201 stages of the Tape Adaptor board (M12027), or from Tape via the pre-set replay level screws (see fig. 6b) of this board. Comparison of symptoms when using these three inputs can, therefore, help initially to locate a fault in this part of the circuit. Note that inputs not in use are shorted.

Signals for recording on tape are also taken from this board, via the pre-set record level screws, to pins 1 and 4 of the Tape Record socket. Pins 3 and 5 of this socket are wired in parallel with those of the Tape Replay socket for convenience when a single record/replay lead is used.

The signals from the Tape Adaptor board are then switched by the channel selection buttons (← Mon, Mon → or Stereo) to the Amplifier boards (M.12017) which are identical and therefore interchangeable.

Pressing the Tape button selects tape replay without interrupting recording of signals from any other input, but it will, of course, cut off those signals from the speakers other than via monitoring off the tape. When looking for a 'no signal' fault check that the Tape button is released.

The Cancel button bypasses all the Bass, Treble and Filter control circuits and besides providing a useful reference standard in operation, may also be helpful in locating a fault in this end of the circuit.

Throughout the unit the left-hand channel components are those nearest the front panel except for the filter coils where the order is reversed.

The pushbutton switches may be dismantled as described on page 4 but this should rarely be necessary and only under exceptional circumstances should switch cleaning fluids be used: abrasives, of course, never.

The DC supply provided on pin 4 of the output plug, derived from diode MR503, is used only as a switching supply for special installations. Its regulation is poor and it is nominally 7-8 volts at 1 milliamp maximum, intermittent rating.

Access to the QUAD 33

Removing the cover provides access to most of the components including the removable printed boards. Further access to the bottom boards and pushbutton switches can be obtained by removing the appropriate plug-in boards, the small knobs in the recessed sub-panel (grub screws), the front panel (4 screws) and the screws

holding the front frame of the pushbutton switch bank concerned, to the front chassis plate. The pushbutton knobs are a push fit and removing the outer two makes it easier to use a screwdriver on the pushbutton switch unit screws.

Pushbutton Mechanisms (See Fig. 1)

The pushbutton switches used in the QUAD 33 are designed for long life and their simple mechanisms and specially plated contacts should obviate the need for any routine servicing. Should it be necessary to remove foreign particles or replace any part, however, each pushbutton slide may be removed from the front as follows :

1. Release the complete switch unit and its attached printed circuit board from the control unit as described above.
2. Ensure the pushbutton to be removed is in the relaxed position.
3. Pull the bronze clip towards the button against the spring and turn it through 90° so that its side flanges rest on the front of the switch stator moulding and is held there by the compression spring.
4. While depressing the button slightly, gently remove the U shaped wire link exposed in 3 above. Then release the pressure on the button.
5. The inner nylon moulding may now be gently withdrawn taking care not to dislodge the moving contacts on their springs. If the switch concerned is one of an inter-dependent bank it is necessary to release the latch-bar by holding one of the other buttons of that bank fully depressed while withdrawing the slide of the button to be removed.

6. Re-assemble in the reverse order ensuring that the longer side flange of the bronze clip rests on the U shaped wire link and that the shorter side flange snaps into the slot between the underside of the body moulding and the metal frame of the switch.

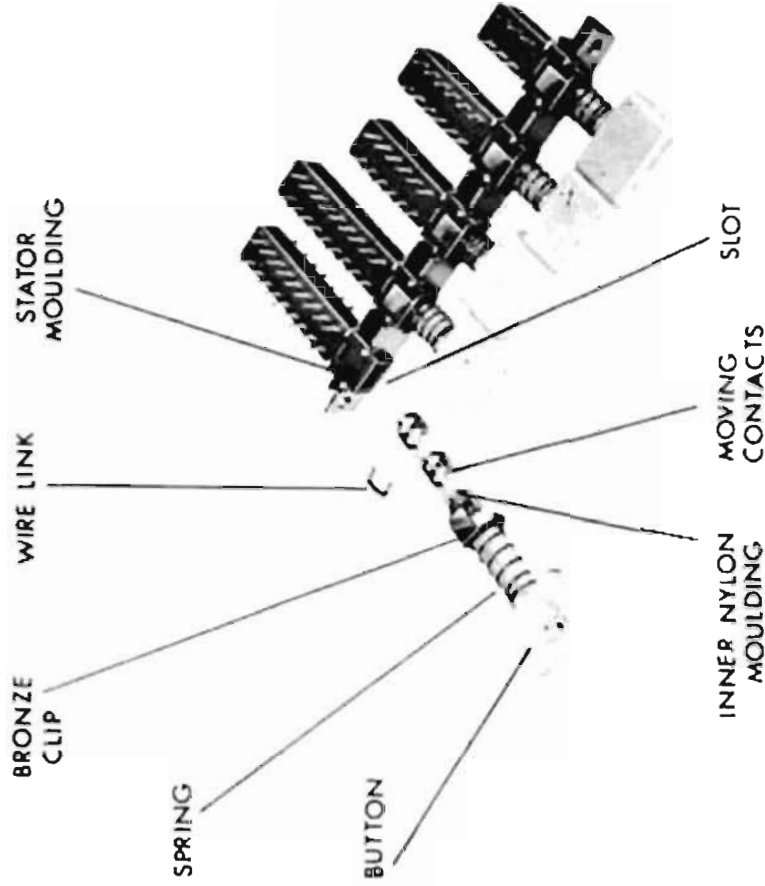

Fig. 1 Dismantling the push buttons

QUAD 303

The QUAD 303 comprises two separate identical circuits and a common power supply. The whole of each amplifier except the output transistors and 2000μ output feed capacitor, is carried on a hinged printed board (M.12038) and the power supply regulator circuit on another (M.12035). The bottom transistors on the heat sink and the printed circuit board nearest the front panel belong to the left-hand channel amplifier.

Output Stage

Each 'triple' configuration is the equivalent of a single transistor of exceptional performance. Thus Tr103, Tr105 and Tr1 can be drawn as an NPN device E1, and Tr104, Tr106 and Tr2 as a PNP device E2, each assumed to incorporate the associated resistors of these circuits. (See Fig. 2).

Driver Stage

The sole purpose of MR100, MR101 and R114 is to limit Tr102 current to about 7mA and these components may be ignored at this stage. The remainder of the Tr100, Tr101 and Tr102 circuitry may be regarded as a single device E3, provided the voltage across C101 remains constant at 9 volts. (See Fig. 2).

Simplified Circuit

Substituting these three equivalents and regarding MR103 and MR 104 as a battery providing steady bias, produces Fig. 2:

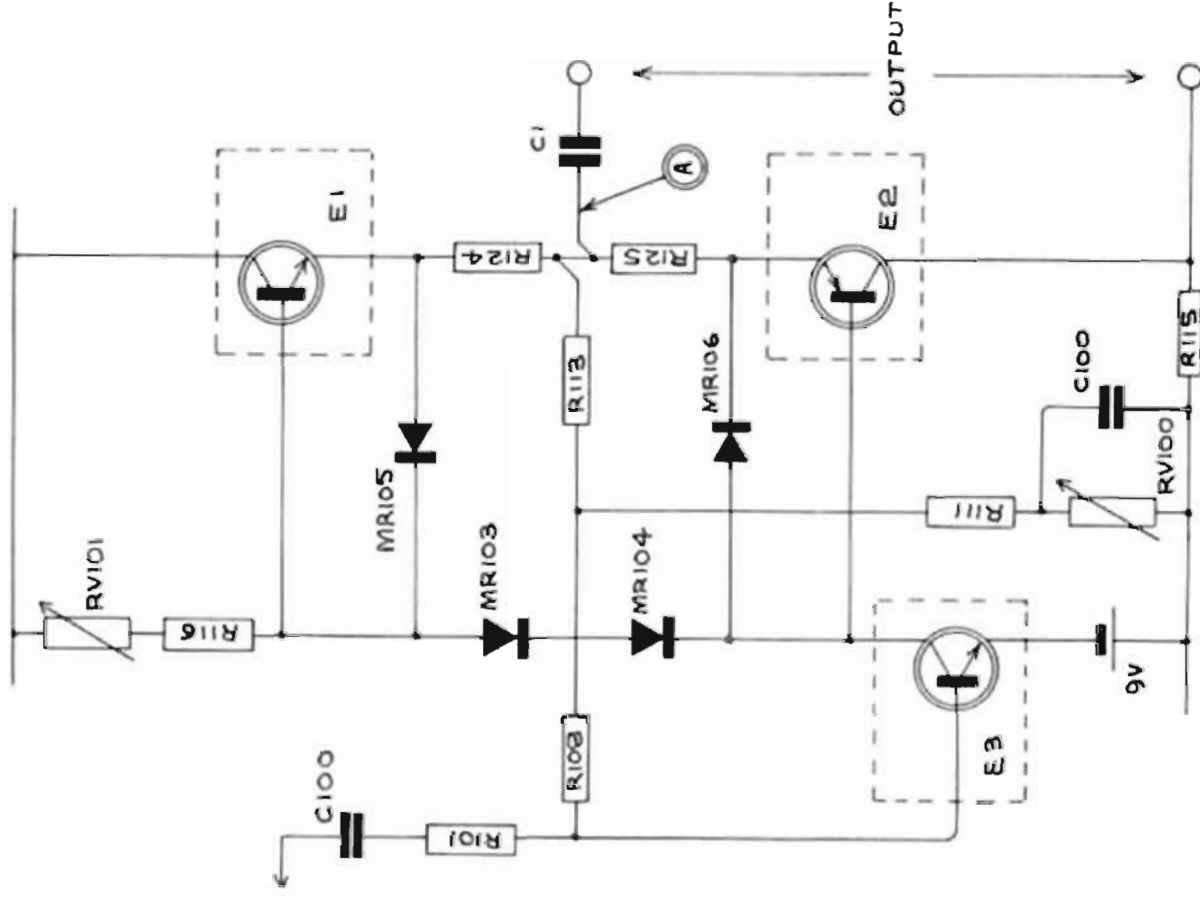

Fig. 2 Simplified circuit, Quad 303

The whole amplifier is enclosed in a DC feedback loop via R113, R111, R110 and RV100, which stabilises the centre point of the output stage (point A) by determining the base voltage of Tr100 with respect to the emitter potential set by R104, R102.

The AC gain is set by the ratios of R113/R111 and R101/R108.

RV101 controls the quiescent current of the output stage (see Setting Up). This should lie between 5 and 10 mA with no signal input to the amplifier.

Each output transistor is protected from passing excessive current by the limiting action of three of the four diodes MR103-MR106, which may be regarded as 65 volt limit batteries. Tr1 is protected by MR105, 103 and 104 and Tr2 by MR103, 104 and 106, and the maximum voltage which can be developed in either R124 or R125 is 1.3 volts or 4.3 amps in 0.3 ohm.

If RV100 controls the voltage of point A correctly it is likely that all the transistors are working.

If E3 is cut off (by shorting Tr102 base to earth) point A should rise to HT rail voltage. If it is turned on (by shorting Tr101 base to earth) point A should fall almost to earth, say +2 to +3 volts. These two tests check the normal functioning of the circuit and may help to pinpoint a fault affecting the voltage at A.

An open circuit in MR103 or MR104 would probably be accompanied by damage to one or more of Tr102, Tr103,

Tr104, Tr105, Tr106, Tr1 and Tr2. In addition the power supply and regulator circuit should be checked.

Regulator Board

The Regulator Tr3 is in the negative lead of the supply and is controlled by Tr201 which in turn is controlled by Tr200. If the supply voltage rises the voltage across R204 rises while that across the zener MR201 remains constant. This turns off Tr200, Tr201 and Tr3 and reduces the terminal voltage.

As this form of regulator is not self-starting, R200, R201 and MR200 are included to ensure that the terminal voltage never falls below half the input voltage.

RV200 sets the base voltage of Tr200 and therefore the regulated terminal voltage.

Setting Up

1. Ensure the mains voltage adjustment is correctly set for the mains supply in use.
2. Adjust RV200 for 67 volts DC between tags 1 and 9 on one driver board.
3. Adjust RV100 for 33.5 volts between tags 5 and 9 on left-hand channel driver board.
4. Adjust RV101 for 5 to 10mA quiescent collector current measured by breaking the external lead to tag 2 of the left-hand driver board and inserting a meter in series at this point, with no signal drive.
5. Repeat 3 and 4 for right-hand channel.

FAULT LOCATION

There is no substitute for thinking a fault through logically from the symptoms to the cure but the following may prove helpful to service engineers not familiar with the equipment.

First carry out a superficial check of the installation, then check all the services available, ensuring that all printed circuit modules and external connectors are pushed firmly home and that the Tape button is relaxed when checking other inputs. Then from the observed symptoms, the effect of operating the controls etc., locate the fault to one unit and then to one channel or stage of that unit. If the fault appears to lie in one of the plug-in boards, change it to prove the diagnosis before changing components on it. When trying the Disc Adaptor board on another side, remember that some of the components are common to more than one position (see Fig. 4).

Satisfactory reproduction from disc proves the whole of the control unit, the power amplifier and the speakers (other than for the tape replay portion of the Tape Adaptor board) leaving only the other signal sources, viz. the radio tuner(s) and the tape recorder.

If radio and tape replay are satisfactory but not disc, try another position of the Disc Adaptor board. If this has no effect other than that expected and another pickup is not available, plug the radio tuner into the Disc input with the adaptor board in the C1 position, to prove whether the fault lies in the pickup or the control unit. If the latter, the Disc pre-amplifier board (M.12019) is suspect.

The tuner may likewise be plugged into the Tape Replay socket with the pre-set screws in the L position to prove

whether the fault lies in the recorder or the control unit Tape Adaptor board, the rest of the circuit having been checked on Radio or Disc.

If tape relay is satisfactory but not radio or disc try another Tape Adaptor board, since parts of this board used for radio and disc are not used for tape replay.

Pressing the Cancel button switches out all the Filter, Bass and Treble circuits and shows whether a fault lies in this part of the circuit or elsewhere.

To check quickly whether a no-signal condition is due to the control unit or the power amplifier, remove the inter-connecting signal lead and touch the live pins (1 and 3) of the Quad 303 input with a simple probe which should produce a fairly substantial hum from both channels equally.

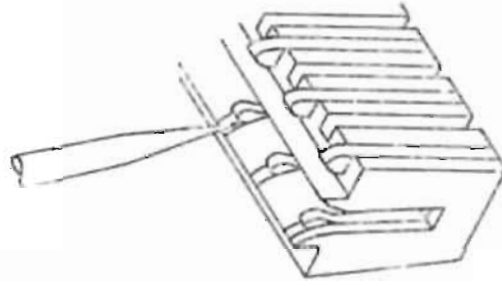

Intermittent contact between the plug in printed circuit boards and their sockets has been known to cause confusing symptoms of erratic operation, attributed to other factors such as pushbutton switches, solder joints etc. This can be cured by closing the gap in the socket contacts by gently inserting a tapering probe of about $\frac{1}{8}$ " diameter between each contact and the adjacent socket wall as illustrated, on both sides of the socket.

Summary of push-button switching

<i>Buttons Pressed</i>		<i>Circuits Selected</i>
← Mon and/or Mon →	Disc	Both channels paralleled to derive mono signal from stereo pickup and fed to left, right or both channels according to buttons pressed
Stereo	Disc Radio 2 or Tape	Each input fed separately to its own channel
← Mon and/or Mon →	Radio 1	Pin 1 of Radio 1 input fed to left, right or both channels according to buttons pressed.
Stereo	Radio 1	Pins 3 and 5 of Radio 1 input separately fed to left and right channels respectively
← Mon	Radio 2 or Tape	Pin 3 of Radio 2 or Tape inputs fed to left channel
← Mon * plus Stereo	Radio 2 or Tape	Pin 3 of Radio 2 or Tape inputs fed to both channels
Mon →	Radio 2 or Tape	Pin 5 of Radio 2 or Tape inputs fed to right channel
Mon → * plus Stereo	Radio 2 or Tape	Pin 5 of Radio 2 or Tape inputs fed to both channels

Note: On controls units earlier than serial number 7500 combinations marked * do not apply there being no internal provision for two channel mono Radio 2 or Tape replay

Modifications

QUAD 33:

1. before serial number 1225, the Disc and Radio inputs used the old DIN system with 3-pin sockets. Pin 1 was then the left-hand channel, pin 3 the right-hand channel and pin 2 earth.
2. before serial number 7500 the Radio 2 and Tape Replay inputs had no 2-channel mono switching facilities, left- and right-hand inputs being confined to their own channel only.

QUAD 303:

1. From serial number 11500, Tr107 and its associated components replaced MR103/104, enabling RV101 (quiescent current control) to vary the voltage between Tr103 and Tr104 bases without altering Tr102 collector current.
2. R202 was 6.8k, now 8.2k.

COMPONENTS LIST

Components and circuit detail may vary slightly depending on the age of the equipment. In case of doubt please refer the query to Acoustical.

Quad 303 Driver Board M12038, Fig. 11

Value	Tol.	Makers reference	Stock no
R100	± 10%	Dubilier BTT or Iskra UPM	187/C
R101	± 5%	Welwyn F20 or Iskra UPM	217/D
R102	± 5%	Dubilier BTT or Iskra UPM	241/A
R104	± 5%	Welwyn F20 or Iskra UPM	217/D
R105	± 10%	Dubilier BTT or Iskra UPM	240/F
R106	± 10%	Dubilier BTT or Iskra UPM	285/A
R107	± 5%	Dubilier BTT or Iskra UPM	250/C
R108	± 5%	Welwyn F20 or Iskra UPM	217/D
R109	± 10%	Dubilier BTT or Iskra UPM	305/F
R110	± 5%	Dubilier BTT or Iskra UPM	232/B
R111	± 5%	Dubilier BTT or Iskra UPM	250/C
R112	± 10%	Dubilier BTT or Iskra UPM	208/M
R113	± 5%	Welwyn F20 or Iskra UPM	203/C
R114	± 10%	Dubilier BTT or Iskra UPM	305/F
R115	± 10%	Morganite 1/2W	330/A
R116	± 10%	Dubilier BTT or Iskra UPM	240/F
R117	± 10%	Dubilier BTT or Iskra UPM	240/F
R118	± 10%	Dubilier BTT or Iskra UPM	258/E
R119	± 10%	Dubilier BTT or Iskra UPM	258/E
R120	± 10%	Dubilier BTT or Iskra UPM	305/F
R121	± 10%	Dubilier BTT or Iskra UPM	305/F
R122	± 10%	Dubilier BTT or Iskra UPM	320/D
R123	± 10%	Dubilier BTT or Iskra UPM	307/B
R124	± 5%	3W AMC Ltd	336/A
R125	± 5%	3W AMC Ltd	336/A
R126	± 10%	Dubilier BTT or Iskra UPM	320/D
R127	± 10%	Dubilier BTT or Iskra UPM	307/B
R128	± 5%	Dubilier BTT	320/E
R129	± 5%	Dubilier BTT	320/E
R130	± 10%	Dubilier BTT or Iskra UPM	193/A
R131	± 5%	Dubilier BTT or Iskra UPM	244/D
R132	± 5%	Dubilier BTT or Iskra UPM	250/C

Value	Tol.	Makers reference	Stock no
RV100	4-7K	Morganite type 62H	374/A
RV101	2-2K	Morganite type 62H	372/B
C100	·64μ	Mullard C426/AS/HO·64	489/A
C101	300μ	10V TCC E1070/3 or Callins SPC 9-3/1	454/A
C102	·01μ	Erie BP	506/H
C103	100p	Erie AP	528/B
C104	12μ	50V TCC E1072/9 or Callins SPC7-9/1	472/B
C105	100p	Erie AP	528/B
C106	50μ	50V TCC E1070/6 or Callins SPC12-9/2	460/B
C107	3-3p	Erie AP	548/H
C108	·1μ	250V TCC PMX4	495/F
C109	1000p	Erie AP	516/J
C110	1000p	Erie AP	516/J
L100		Dubilier 665 or Radiospares T/V 2A 440/B	
Tr100		SGS BC 154	
Tr101		BC 109 or BC 149 or BC 184K	
Tr102		SGS U17219	
Tr103		SGS U17219	
Tr104		SGS U17229	
Tr105		RCA 38496	
Tr106		RCA 38495	
Tr107		BC 109 or BC 149 or BC 184K	
MR100		Texas Instruments 1S920	
MR101		Texas Instruments 1S920	
MR105		Texas Instruments 1S920	
MR106		Texas Instruments 1S920	

Quad 303—Regulator Board M12035, Fig. 12

	Value	Tol.	Makers reference	Stock no
R200	10K	±10%	Dubilier BTT or Iskra UPM	230/E
R201	10K	±10%	Dubilier BTT or Iskra UPM	230/E
R202	8-2K	±5%	Dubilier BTT or Iskra UPM	232/B
R203	2-2K	±5%	Dubilier BTT or Iskra UPM	250/A
R204	10K	±10%	Dubilier BTT or Iskra UPM	230/E
R205	4-7K	±10%	Dubilier BTT or Iskra UPM	240/F
R206	10	±10%	Dubilier BTT or Iskra UPM	320/D
R207	68	±10%	Dubilier BTT or Iskra UPM	307/B
C200	330p	±20%	Erie AP	523/C
C201	2-2 μ		250V Hunts AM 3437 or Mullard C280AE/A2M2	483/A
Tr200			SGS U17229	
Tr201			RCA 38495	
MR200			Texas Instruments 1S920	
MR201			Texas Instruments 1S2120 or SGS ZE12V7	
RV200	4-7K	±20%	Morganite Type 62H	

Quad 303: General, Fig. 10

R1	2-2K	±10%	Dubilier BTT or Iskra UPM	250/A
R2	100K	±10%	Dubilier BTT or Iskra UPM	200/A
C1	2000 μ		100V TCC CE36E PVC/Sleeve or Callins LC13-12/1	448/A
C2	2000 μ		100V TCC CE36E PVC/Sleeve or Callins LC13-12/1	448/A
C3	2000 μ		100V TCC CE36E PVC/Sleeve or Callins LC13-12/1	448/A
C4	.03 μ	-20+80%	Erie CD 18	448/A 502/D
MR1			Texas Instruments 1S421	
MR2			Texas Instruments 1S421R	

Value Tol. Makers reference Stock no

MR3			Texas Instruments 1S421	
MR4			Texas Instruments 1S421R	
Tr1			RCA 38494	
Tr2			RCA 38494	
Tr3			RCA 16012 (or 40411*)	
V1			Hivac 29L	
FS1			2A Antisurge (20×5mm) Beswick TDC 123	
T1			Mains Transformer (dual voltage) to Drg A12085	

*An alternative for this circuit only

Quad 33 Disc Board M.12021, Fig. 4

R101	68K	±5%	Dubilier BTT or Iskra UPM	205/C
R102	68K	±5%	Dubilier BTT or Iskra UPM	205/C
R103	68K	±5%	Dubilier BTT or Iskra UPM	205/C
R104	68K	±5%	Dubilier BTT or Iskra UPM	205/C
R105	470	±5%	Dubilier BTT or Iskra UPM	270/F
R106	470	±5%	Dubilier BTT or Iskra UPM	270/F
R107	220	±5%	Dubilier BTT or Iskra UPM	285/C
R108	220	±5%	Dubilier BTT or Iskra UPM	285/C
R109	8-2K	±5%	Dubilier BTT or Iskra UPM	232/B
R110	8-2K	±5%	Dubilier BTT or Iskra UPM	232/B
R111	3-3K	±10%	Dubilier BTT or Iskra UPM	244/B
R112	3-3K	±10%	Dubilier BTT or Iskra UPM	244/B
R113	100K	±10%	Dubilier BTT or Iskra UPM	200/A
R114	100K	±10%	Dubilier BTT or Iskra UPM	200/A
R115	3-3K	±10%	Dubilier BTT or Iskra UPM	244/B
R116	3-3K	±10%	Dubilier BTT or Iskra UPM	244/B
C101	.01 μ	±10%	Hunts SLM13A	506/G
C102	.01 μ	±10%	Hunts SLM13A	506/G
C103	.029 μ	±10%	125V Evox Type MF	503/A
C104	.029 μ	±10%	125V Evox Type MF	503/A
C105	1500P	±10%	Hunts SLM50A	515/Q

	<i>Value</i>	<i>Tol.</i>	<i>Makers reference</i>	<i>Stock no</i>
C106	1500P	± 10%	Hunts SLM50A	515/Q
C107	.01 μ	± 10%	Hunts SLM13A	506/G
C108	.01 μ	± 10%	Hunts SLM13A	506/G

Quad 33 Pre-amplifier Board M.12019, Fig. 5

R300	560	± 10%	Dubilier BTT or Iskra UPM	265/A
R301	47K	± 5%	Welwyn F20 or Iskra UPM	208/G
R302	47K	± 5%	Welwyn F20 or Iskra UPM	208/G
R303	120K	± 5%	Welwyn F20 or Iskra UPM	195/C
R304	120K	± 5%	Welwyn F20 or Iskra UPM	195/C
R305	82K	± 5%	Welwyn F20 or Iskra UPM	203/C
R306	5-6K	± 5%	Welwyn F20 or Iskra UPM	237/D
R307	5-6K	± 5%	Welwyn F20 or Iskra UPM	237/D
R308	82K	± 5%	Welwyn F20 or Iskra UPM	203/C
R309	47K	± 5%	Dubilier BTT or Iskra UPM	208/G
R310	47K	± 5%	Dubilier BTT or Iskra UPM	208/G
R311	560	± 10%	Dubilier BTT or Iskra UPM	265/A
R312	1K	± 10%	Dubilier BTT or Iskra UPM	258/E
R313	1K	± 10%	Dubilier BTT or Iskra UPM	258/E
R314	560	± 10%	Dubilier BTT or Iskra UPM	265/A
R315	3-3K	± 5%	Welwyn F20 or Iskra UPM	244/D
R316	3-3K	± 5%	Welwyn F20 or Iskra UPM	244/D
R317	1K	± 10%	Dubilier BTT or Iskra UPM	258/E
R318	1K	± 10%	Dubilier BTT or Iskra UPM	258/E
C300	25 μ		25V TCC E1072/7 or Callins K8156	465/G
C301	100 μ		6V TCC E1072/4 or Callins K8092	455/B
C302	100 μ		6V TCC E1072/4 or Callins K8092	455/B
C303	25 μ		25V TCC E1072/7 or Callins K8156	465/G
C305	.33 μ		Hunts AM 3428 or Mullard C280AE/A330K	493/A

	<i>Value</i>	<i>Tol.</i>	<i>Makers reference</i>	<i>Stock no</i>
C306	.33 μ		Hunts AM 3428 or Mullard C280AE/A330K	493/A
C307	25 μ		25V TCC E1072/7 or K8156	465/G
C308	25 μ		25V TCC E1072/7 or K8156	465/G
C309	2000p		Erie AP Epitex Insulated	515/E
C310	2000p		Erie AP Epitex Insulated	515/E
C311	50 μ		12V TCC E 1072/6 or Callins KSPC4-4/1	460/A
C312	50 μ		12V TCC E 1072/6 or Callins KSPC4-4/1	460/A
C313	100 μ		12V TCC E 1071/4 or Callins KSPC7-4/1	455/C
Tr300			BC109	
Tr301			BC109	
Tr302			BC109	
Tr303			BC109	

Quad 33 Tape Board M.12027, Fig. 6

R200	15K	± 5%	Dubilier BTT or Iskra UPM	224/D
R201	33K	± 5%	Dubilier BTT or Iskra UPM	209/E
R202	3-9K	± 5%	Dubilier BTT or Iskra UPM	241/B
R203	220K	± 5%	Dubilier BTT or Iskra UPM	187/D
R204	220K	± 5%	Dubilier BTT or Iskra UPM	187/D
R205	4-7K	± 10%	Dubilier BTT or Iskra UPM	240/F
R206	4-7K	± 10%	Dubilier BTT or Iskra UPM	240/F
R207	3-9K	± 5%	Dubilier BTT or Iskra UPM	241/B
R208	820	± 5%	Dubilier BTT or Iskra UPM	260/C
R209	180	± 5%	Dubilier BTT or Iskra UPM	290/D
R210	3-9K	± 5%	Dubilier BTT or Iskra UPM	241/B
R211	820	± 5%	Dubilier BTT or Iskra UPM	260/C
R212	180	± 5%	Dubilier BTT or Iskra UPM	290/D
R213	33K	± 5%	Dubilier BTT or Iskra UPM	209/E
R214	3-9K	± 5%	Dubilier BTT or Iskra UPM	241/B
R215	220K	± 5%	Dubilier BTT or Iskra UPM	187/D

	<i>Value</i>	<i>Tol.</i>	<i>Makers reference</i>	<i>Stock no</i>
R216	220K	±5%	Dubilier BTT or Iskra UPM	187/D
R217	15K	±5%	Dubilier BTT or Iskra UPM	224/D
R218	1M	±10%	Dubilier BTT or Iskra UPM	165/C
R219	1M	±10%	Dubilier BTT or Iskra UPM	165/C
R220	1M	±10%	Dubilier BTT or Iskra UPM	165/C
R221	1M	±10%	Dubilier BTT or Iskra UPM	165/C
C200	·33μ		Hunts AM 3428 or Mullard C280AE/A330K	493/A
C201	·33μ		Hunts AM 3428 or Mullard C280 AE/A 330K	493/A
C202	·33μ		Hunts AM 3428 or Mullard C280 AE/A 330K	493/A
C203	·33μ		Hunts AM 3428 or Mullard C280 AE/A 330K	493/A
Tr200			BC 109	
Tr201			BC 109	

Quad 33 Amplifier Board M.12017, Fig. 7

R400	15K	10%	Dubilier BTT or Iskra UPM	224/C
R401	15K	10%	Dubilier BTT or Iskra UPM	224/C
R402	47K	10%	Dubilier BTT or Iskra UPM	208/F
R404	270	10%	Dubilier BTT or Iskra UPM	283/A
R405	4·7K	10%	Dubilier BTT or Iskra UPM	240/F
R406	270K	5%	Welwyn F20 or Iskra UPM	185/F
R407	100K	5%	Welwyn F20 or Iskra UPM	200/D
R408	4·7K	10%	Dubilier BTT or Iskra UPM	240/F
R409	15K	10%	Dubilier BTT or Iskra UPM	224/C
R410	10K	10%	Dubilier BTT or Iskra UPM	230/E
R411	1·8K	5%	Welwyn F20 or Iskra UPM	253/B
R412	470	5%	Welwyn F20 or Iskra UPM	270/F
R413	1·2K	10%	Dubilier BTT or Iskra UPM	257/A

	<i>Value</i>	<i>Tol.</i>	<i>Makers reference</i>	<i>Stock no</i>
C400	·068μ		250V Hunts AM3421 or Mullard C280AE/P68K or PMX8	500/D 484/
C401	2μ		25V Callins KSPC 57-7/3	
C402	2·2μ		250V Hunts AM3437 or Mullard C280AE/A2M2	483/A
C403	2·2μ		250V Hunts AM3437 or Mullard C280AE/A2M2	483/A
C404	1000p		Erie AP Epitex Insulated	516/J
C405	50μ		12V TCC E1072/6 or Callins KSPC4-4/1	460/A
C406	12μ		50V TCC E1072/9 or Callins KSPC7-9/1	472/B
C407	2·2μ		250V Hunts AM3437 or Mullard C280AE/A2M2	483/A
C408	1000p		Erie AP Epitex Insulated	516/J
Tr400			BC109	
Tr401			BC109	
Tr402			BC109	

Quad 33 Power Supply Board M.12032, Fig. 9

R500	120	±10%	Dubilier BTT or Iskra UPM	300/B
R501	120	±10%	Dubilier BTT or Iskra UPM	300/B
R502	220	±10%	Dubilier BTT or Iskra UPM	285/A
C500	640μ		16V Mullard C437CB/E640	451/A
C501	640μ		16V Mullard C437CB/E640	451/A
C502	400μ		25V Mullard C437AR/F400	453/C
C503	50μ		12V TCC E1072/6 or Callins KSPC4-4/1	460/A
C504	50μ		12V TCC E1072/6 or Callins KSPC4-4/1	460/A

	Value	Tol.	Makers reference	Stock no
MR500			Texas Instruments 1S2120	
MR501			Texas Instruments 1S920	
MR502			Texas Instruments 1S920	
MR503			Texas Instruments 1S920	
			Mains Transformer to Acoustical Drg. A12033 Iss. 2	

	Value	Tol.	Makers reference	Stock no
C10	.033 μ	\pm 10%	Hunts SLM46A	502/A
C11	2200p	\pm 10%	Hunts SLM60A	514/N
C12	2200p	\pm 10%	Hunts SLM60A	514/N
C13	2200p	\pm 10%	Hunts SLM60A	514/N
C14	2200p	\pm 10%	Hunts SLM60A	514/N
C15	.015 μ	\pm 10%	Hunts SLM41A	505/O
C16	.015 μ	\pm 10%	Hunts SLM41A	505/O

L1 To Acoustical Drg A11902
L2 To Acoustical Drg A11902

Quad 33 Filter Board M.12029, Fig. 8

R3	5-6K	\pm 5%	Dubilier BTT or Iskra UPM	237/D
R4	5-6K	\pm 5%	Dubilier BTT or Iskra UPM	237/D
R5	10K	\pm 10%	Dubilier BTT or Iskra UPM	230/E
R6	560	\pm 10%	Dubilier BTT or Iskra UPM	265/A
R7	1M	\pm 10%	Dubilier BTT or Iskra UPM	165/C
R8	100	\pm 10%	Dubilier BTT or Iskra UPM	305/F
R9	100	\pm 10%	Dubilier BTT or Iskra UPM	305/F
R10	5-6K	\pm 5%	Dubilier BTT or Iskra UPM	237/D
R11	5-6K	\pm 5%	Dubilier BTT or Iskra UPM	237/D
R12	1M	\pm 10%	Dubilier BTT or Iskra UPM	165/C
R13	10K	\pm 10%	Dubilier BTT or Iskra UPM	230/E
R14	560	\pm 10%	Dubilier BTT or Iskra UPM	265/A
R15	4-7K	\pm 10%	Dubilier BTT or Iskra UPM	240/F
R16	4-7K	\pm 10%	Dubilier BTT or Iskra UPM	240/F
C1	.033 μ	\pm 10%	Hunts SLM46A	502/A
C2	.033 μ	\pm 10%	Hunts SLM46A	502/A
C3	.033 μ	\pm 10%	Hunts SLM46A	502/A
C4	.033 μ	\pm 10%	Hunts SLM46A	502/A
C5	100 μ		6V TCC E1072/4 or Callins K8092	455/B
C6	100 μ		6V TCC E1072/4 or Callins K8092	455/B
C7	.033 μ	\pm 10%	Hunts SLM46A	502/A
C8	.033 μ	\pm 10%	Hunts SLM46A	502/A
C9	.033 μ	\pm 10%	Hunts SLM46A	502/A

Quad 33 General, Fig. 3

RV1-2	50K+50K		Plessey EC2S to Drg 404/8/02403/015	385/B
RV3/6	10K+10K		Morganite to Acoustical Drg A11926-1	376/B
RV4/7	47K+47K		Morganite to Acoustical Drg A11924-1	382/A
RV5	1K		AB Metal to Acoustical Drg A11923-1	370/D
RV8-9	25K+25K		Morganite to Acoustical Drg A11925-1	380/A
C17	1000p		Erie AD or equivalent	516/I
LP1	1W		5mm Lilliput Tubular Type 674	690/I
FS1			2A (250V) Antisurge (20x5mm) Beswick TDC 123 Mains Filter SKF24R Dubilier	675/N 441/A

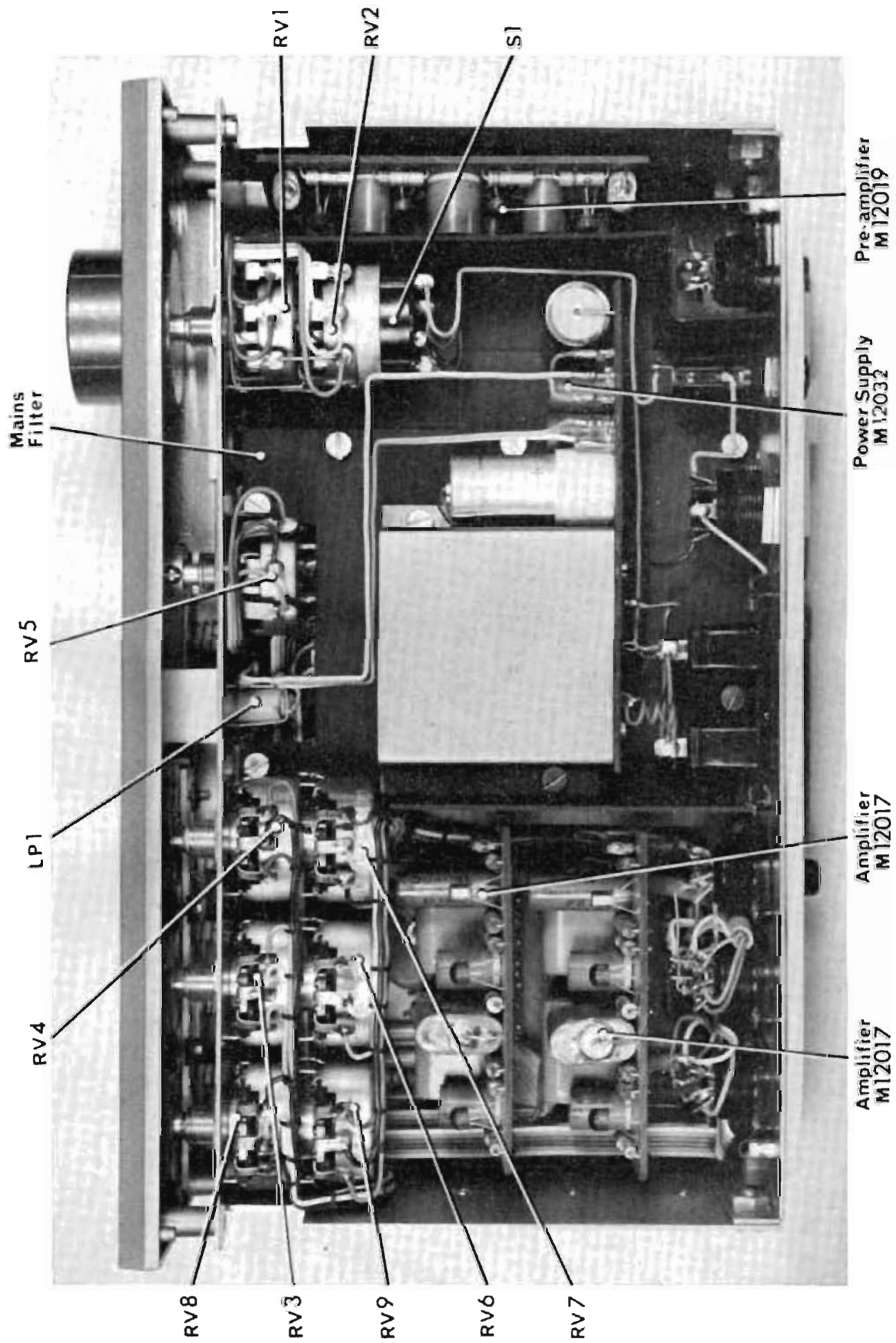
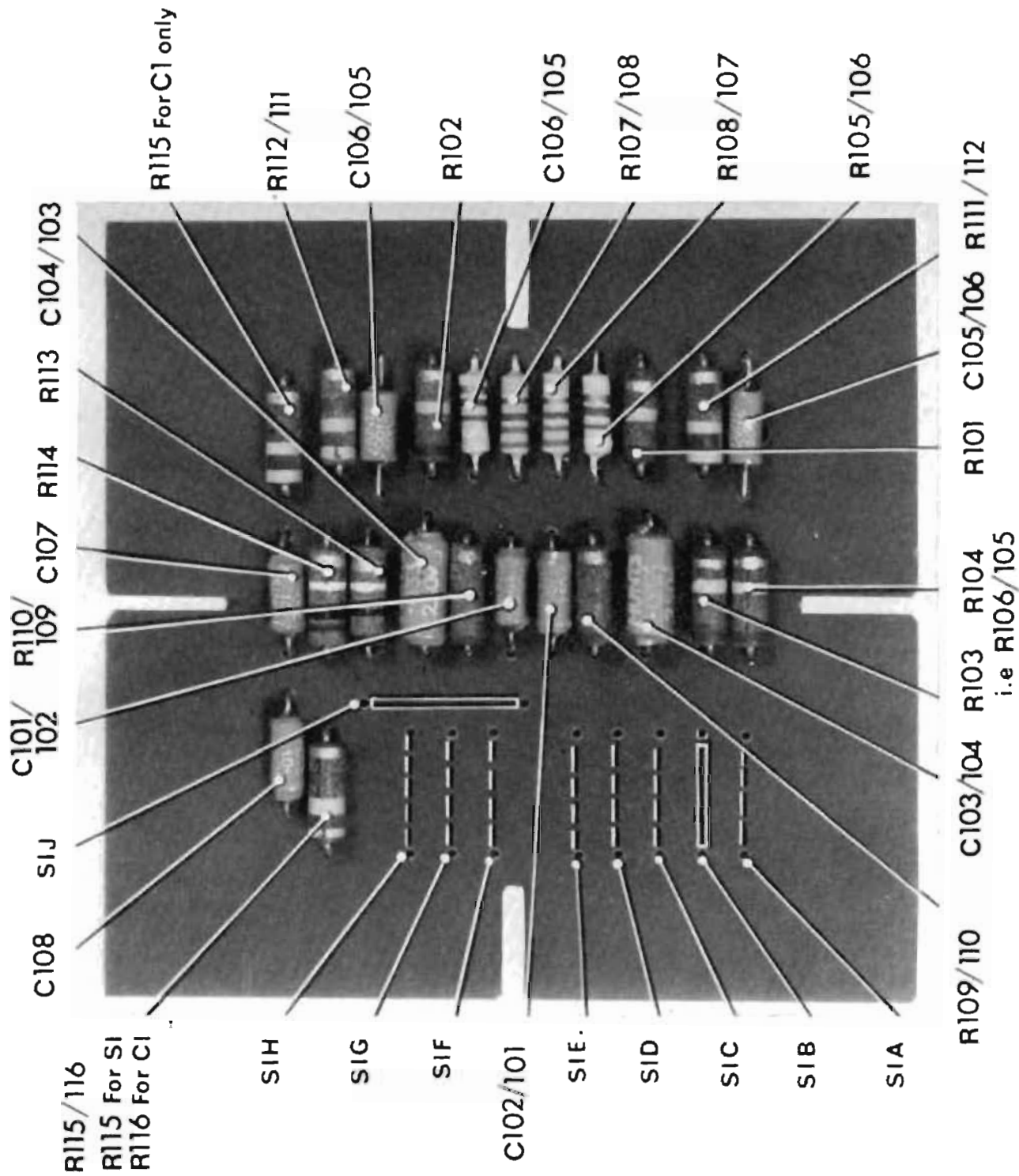

Fig. 3 Top view Quad 33



1st number is component ref. in M1, 2nd number is component ref. in M2.
 i.e. R106/105 is R106 when adaptor is in M1, and R105 when adaptor is in M2.

Fig. 4 Disc Adaptor Board M.12021

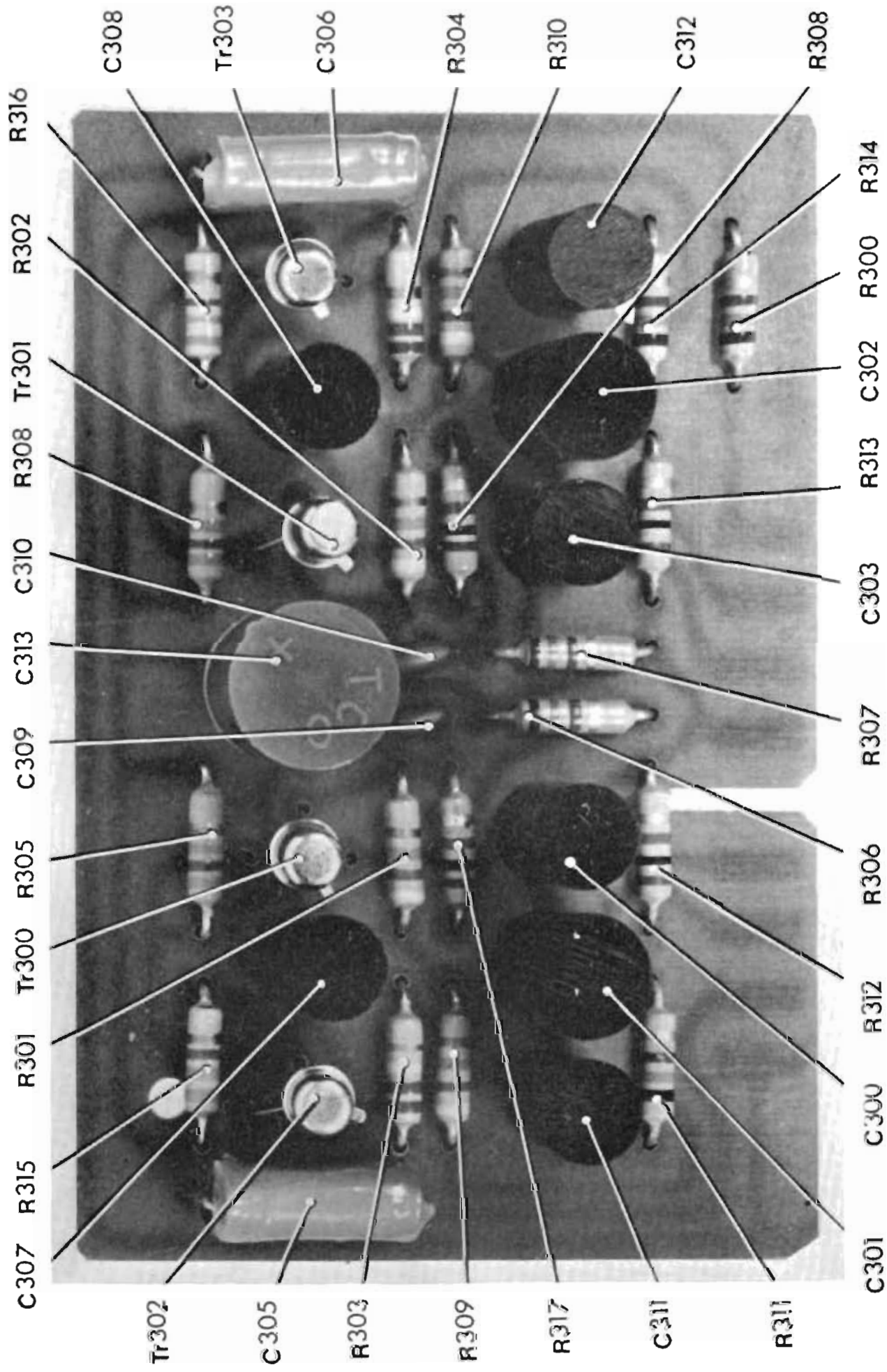

Fig. 5 Disc Pre-Amplifier Board M.12019 (issue 4)

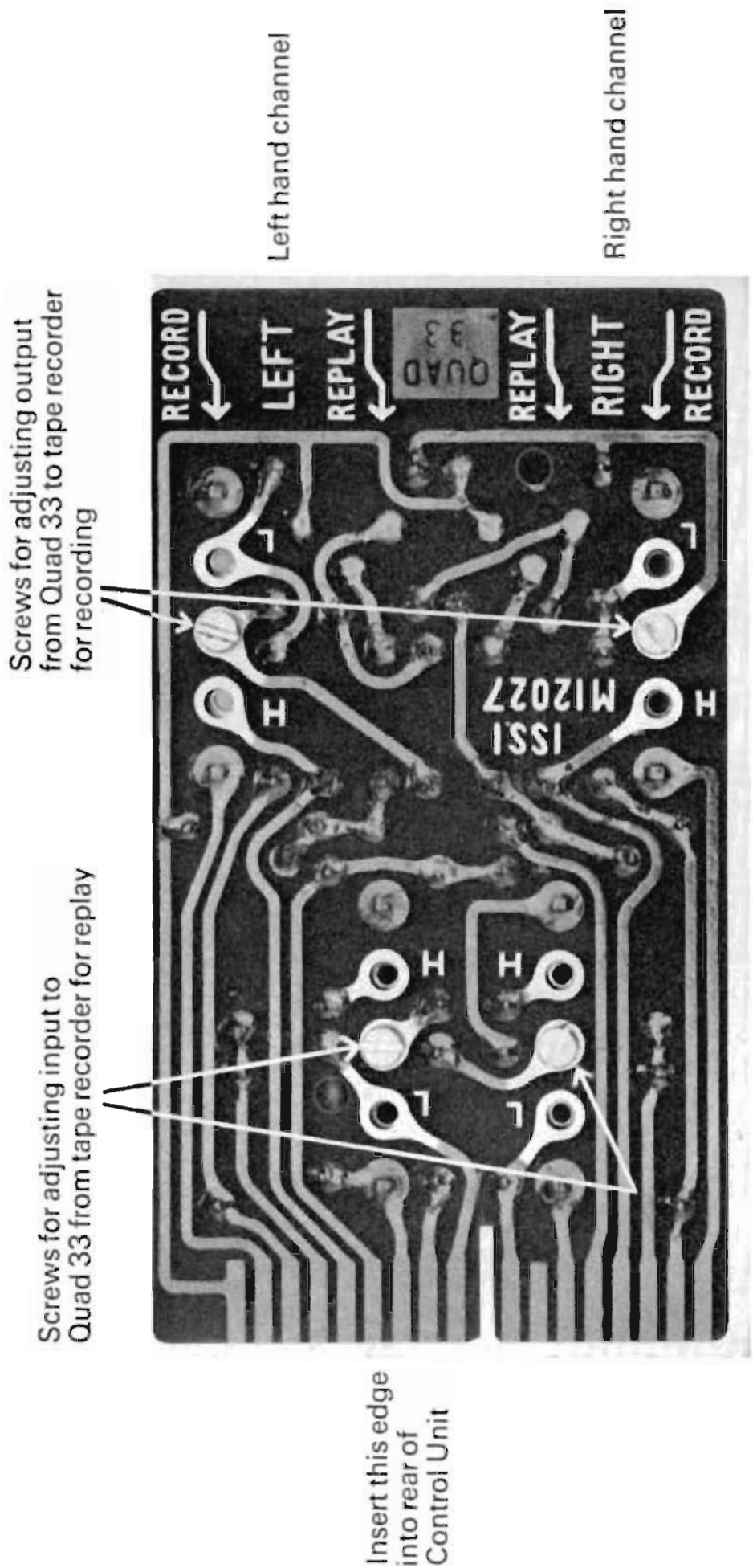

Fig. 6 (a) Tape Adaptor Board under side showing pre-set signal level screws in the M position

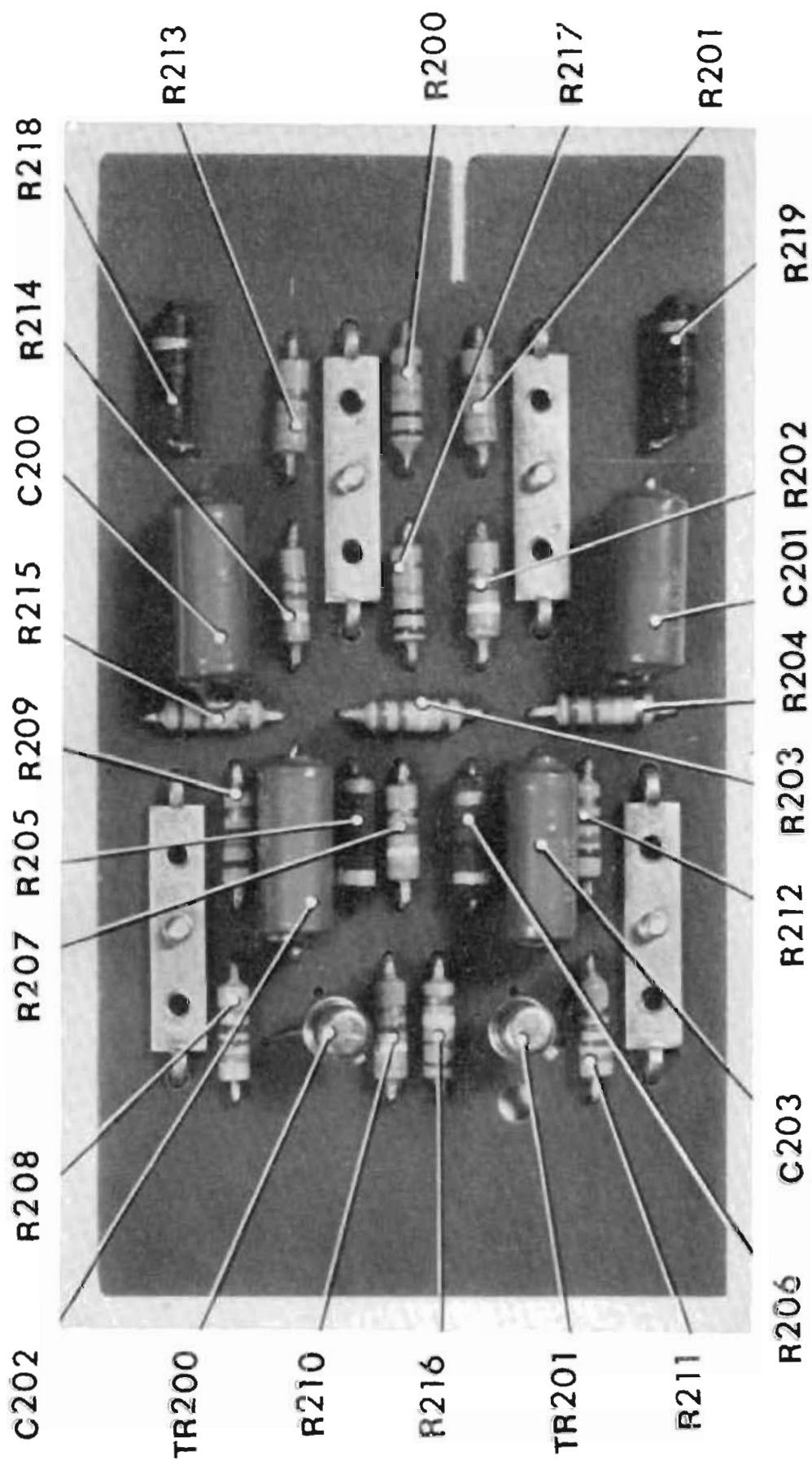

Fig. 6 (b) Tape Adaptor Board M.12027, top side (issue 1)

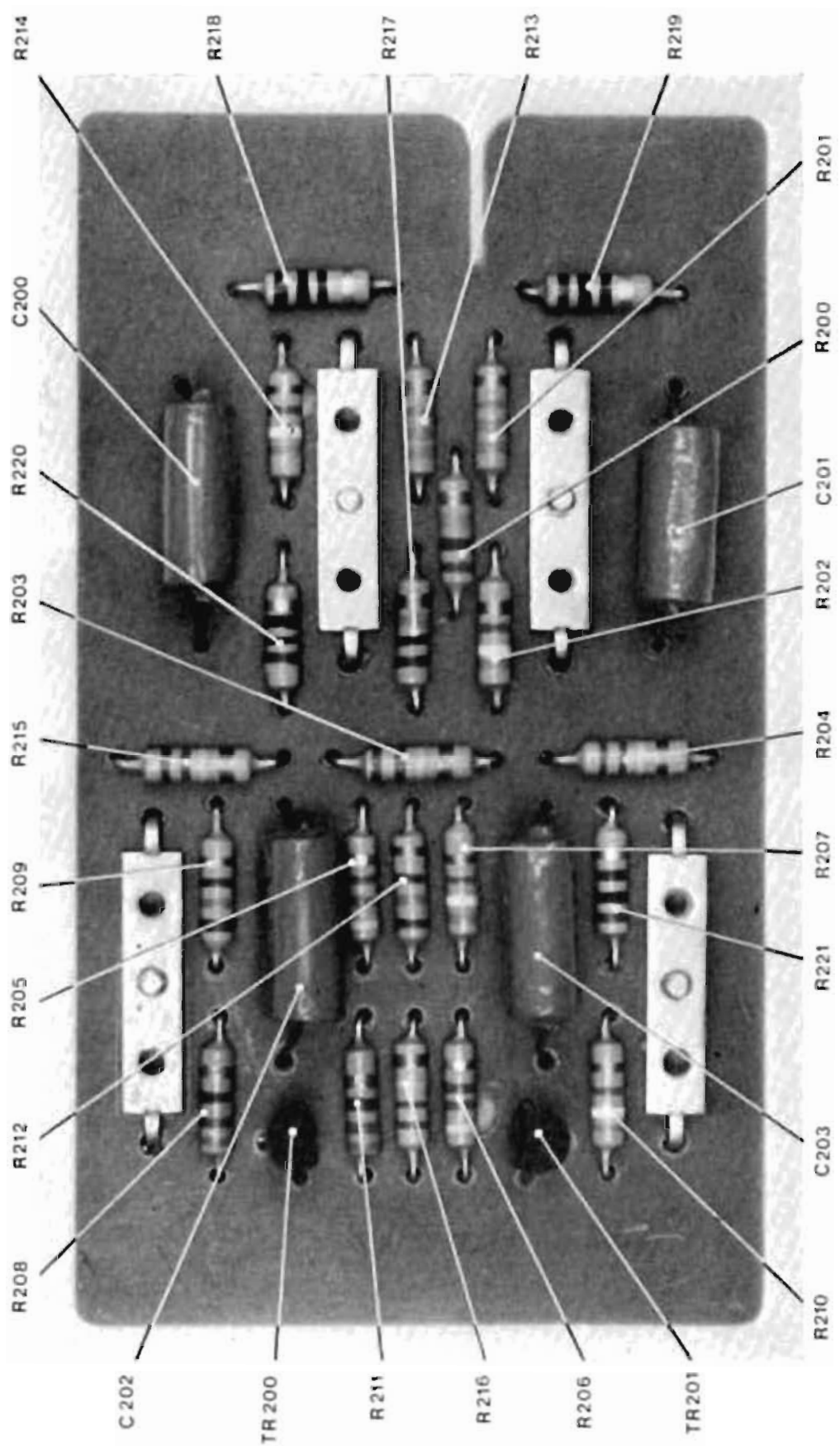

Fig. 6 (c) Tape Adaptor Board M.12027, top side (issue 3)

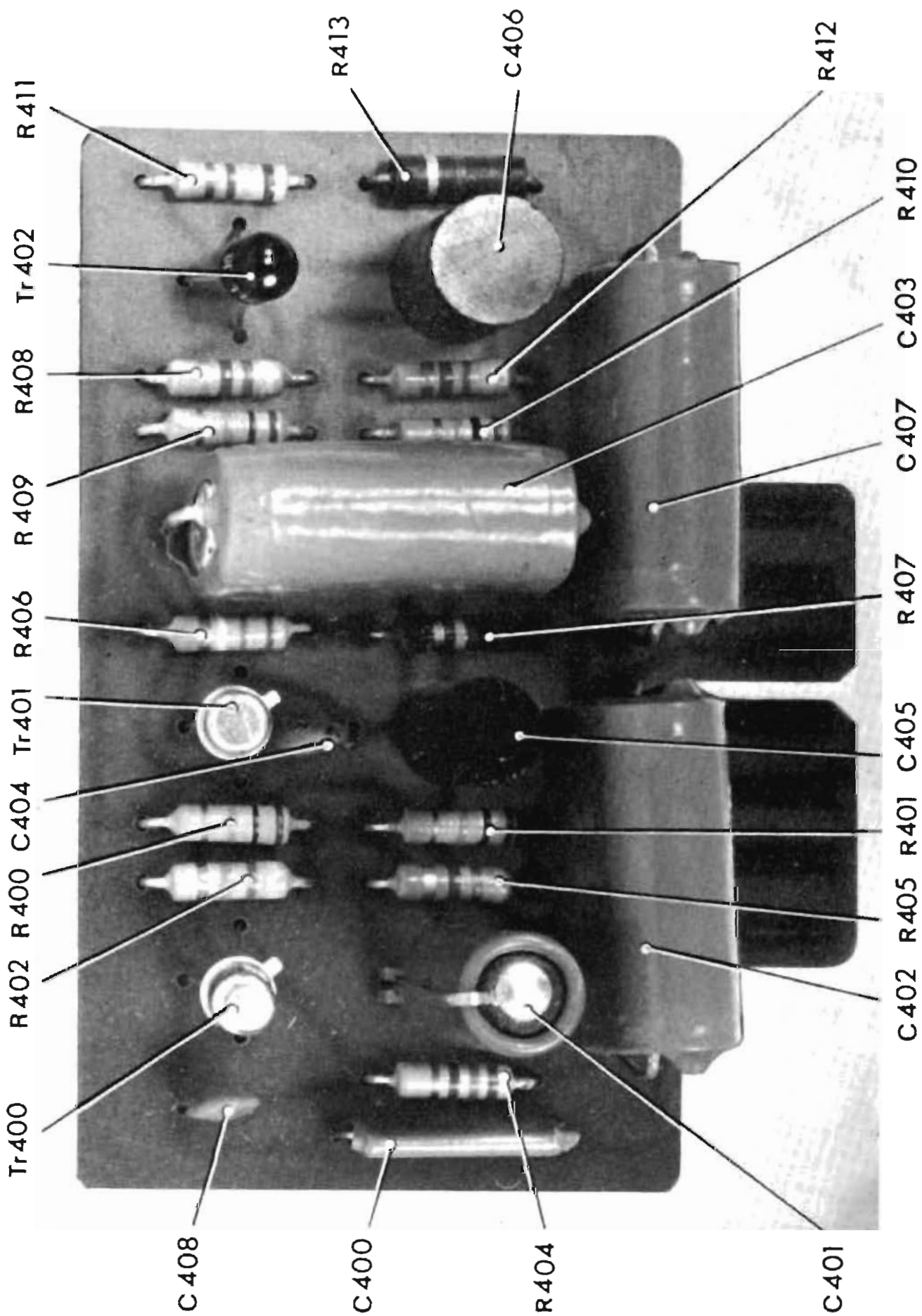

Fig. 7 (a) Amplifier Board M.12017 (issue 2)

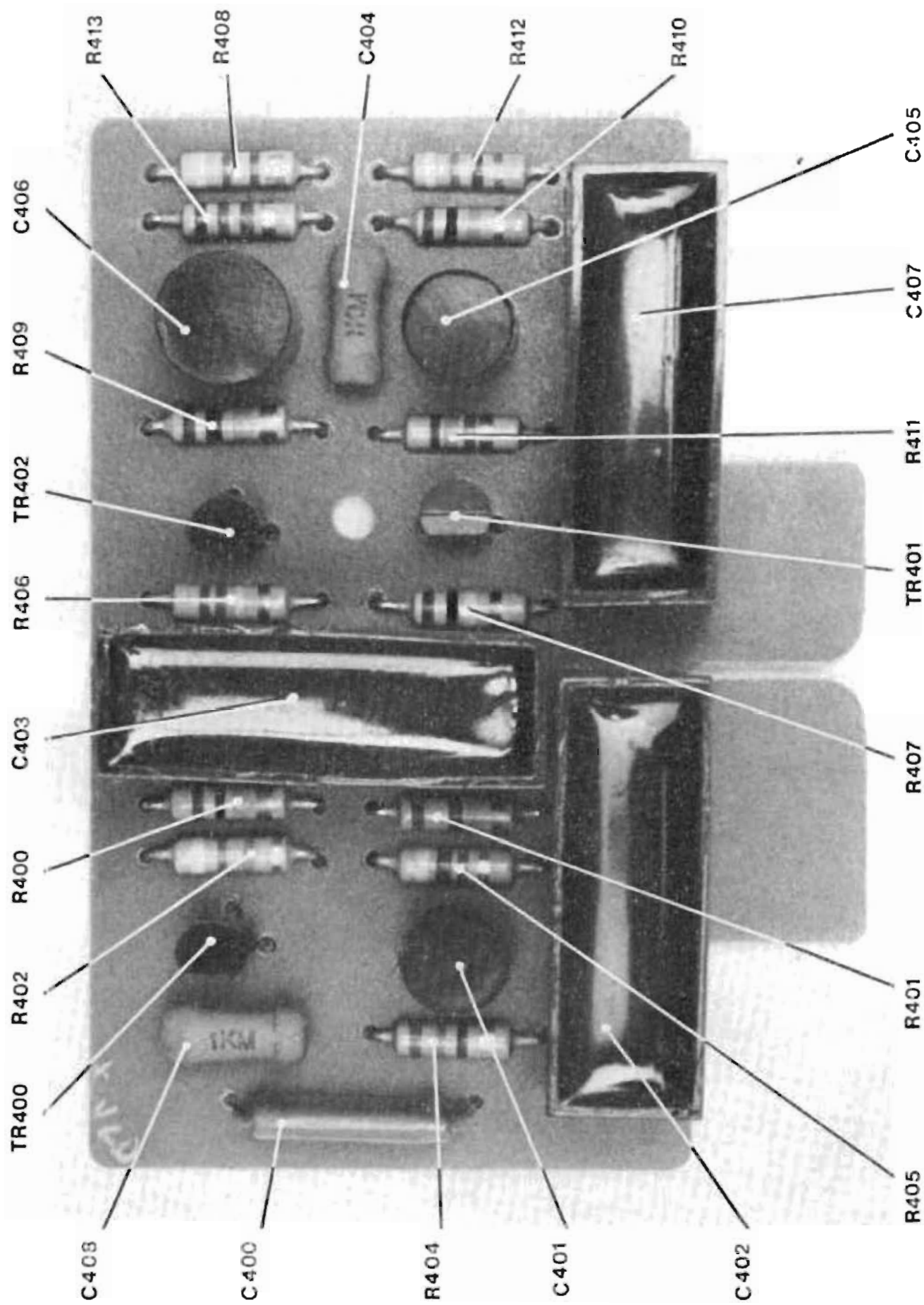

Fig. 7 (b) Amplifier Board M.12017 (issue 3)

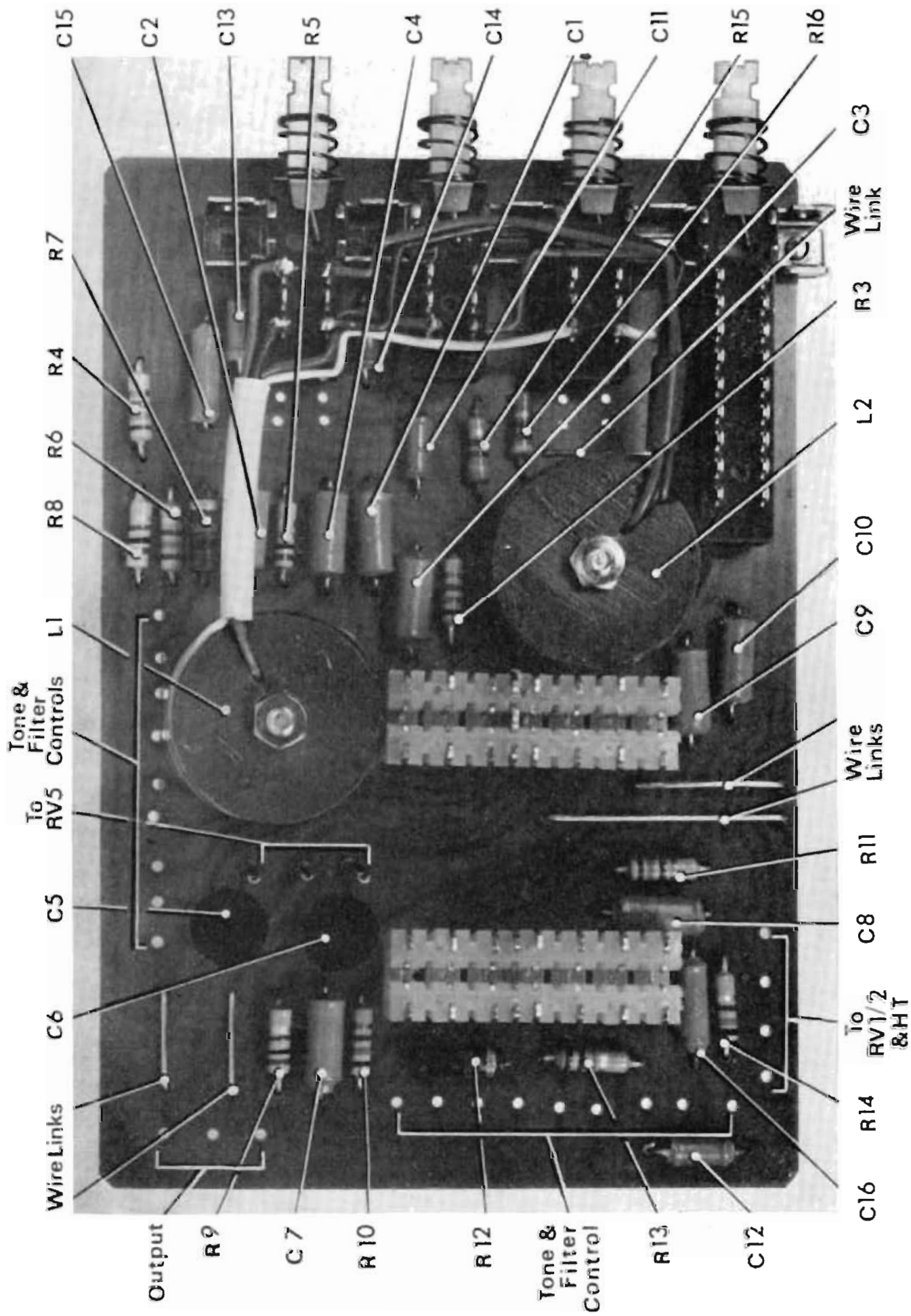

Fig. 8 Filter Board M.12029

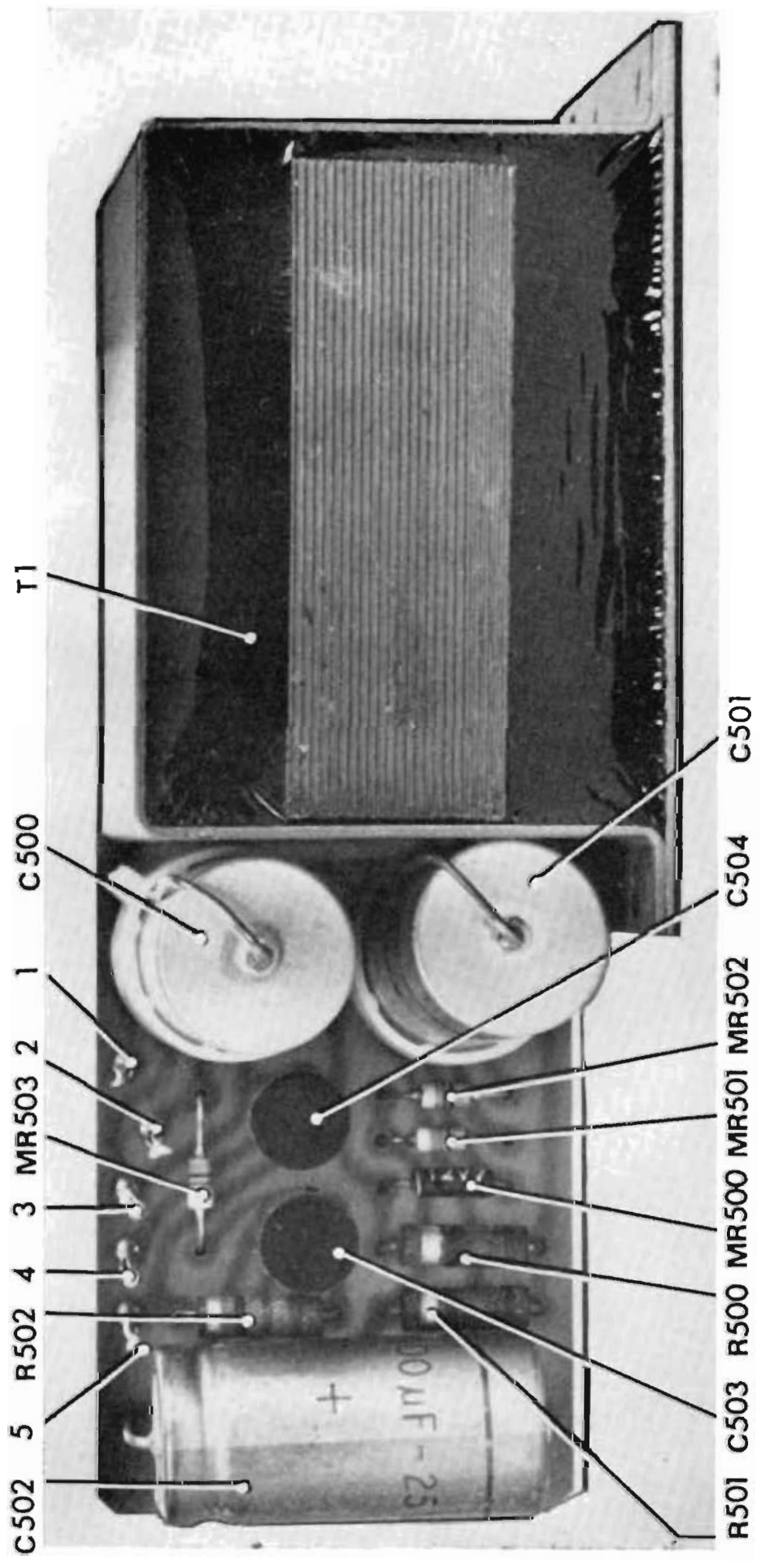

Fig. 9 Power Supply Board M.12032

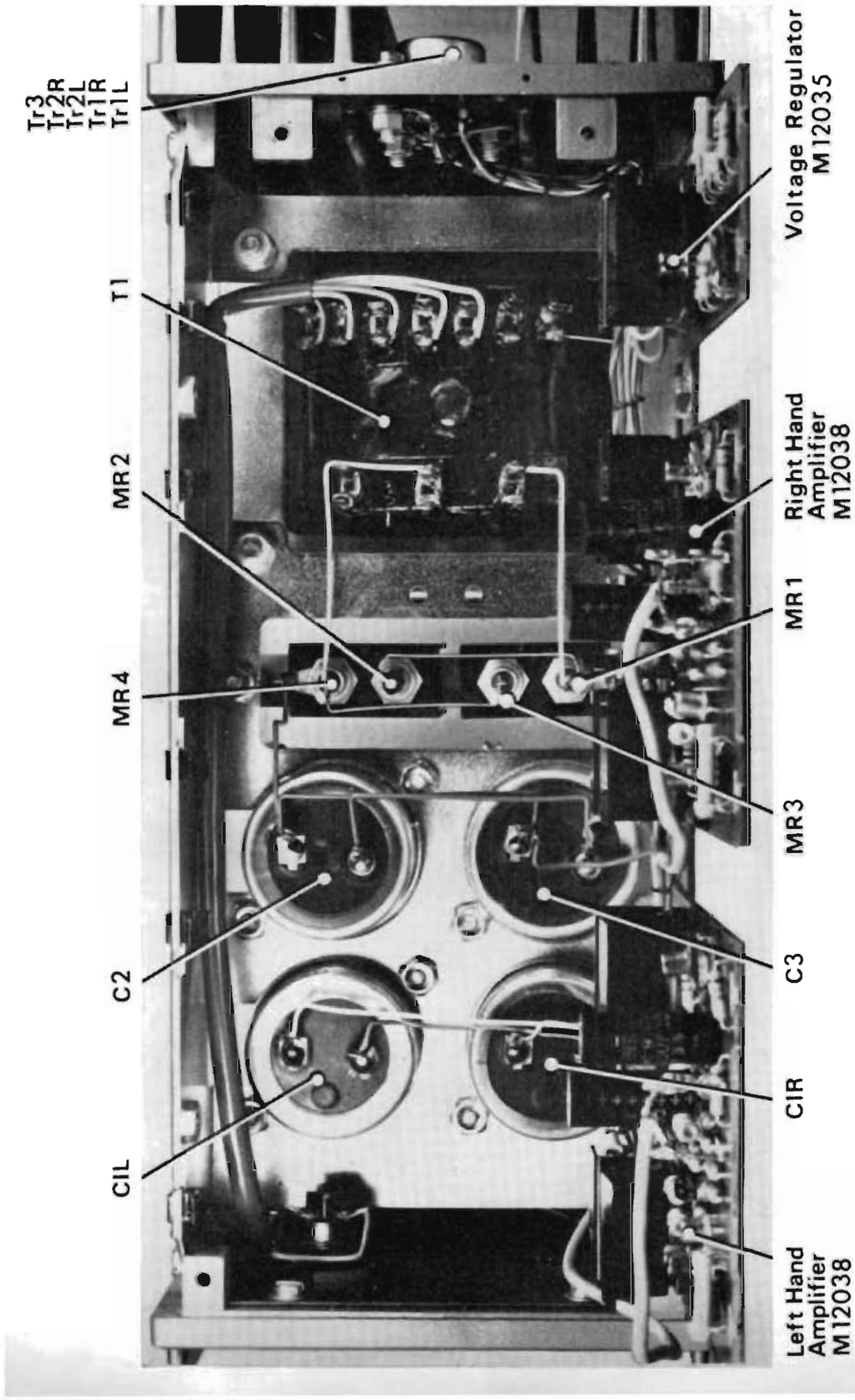

Fig. 10 Under side view, Quad 303

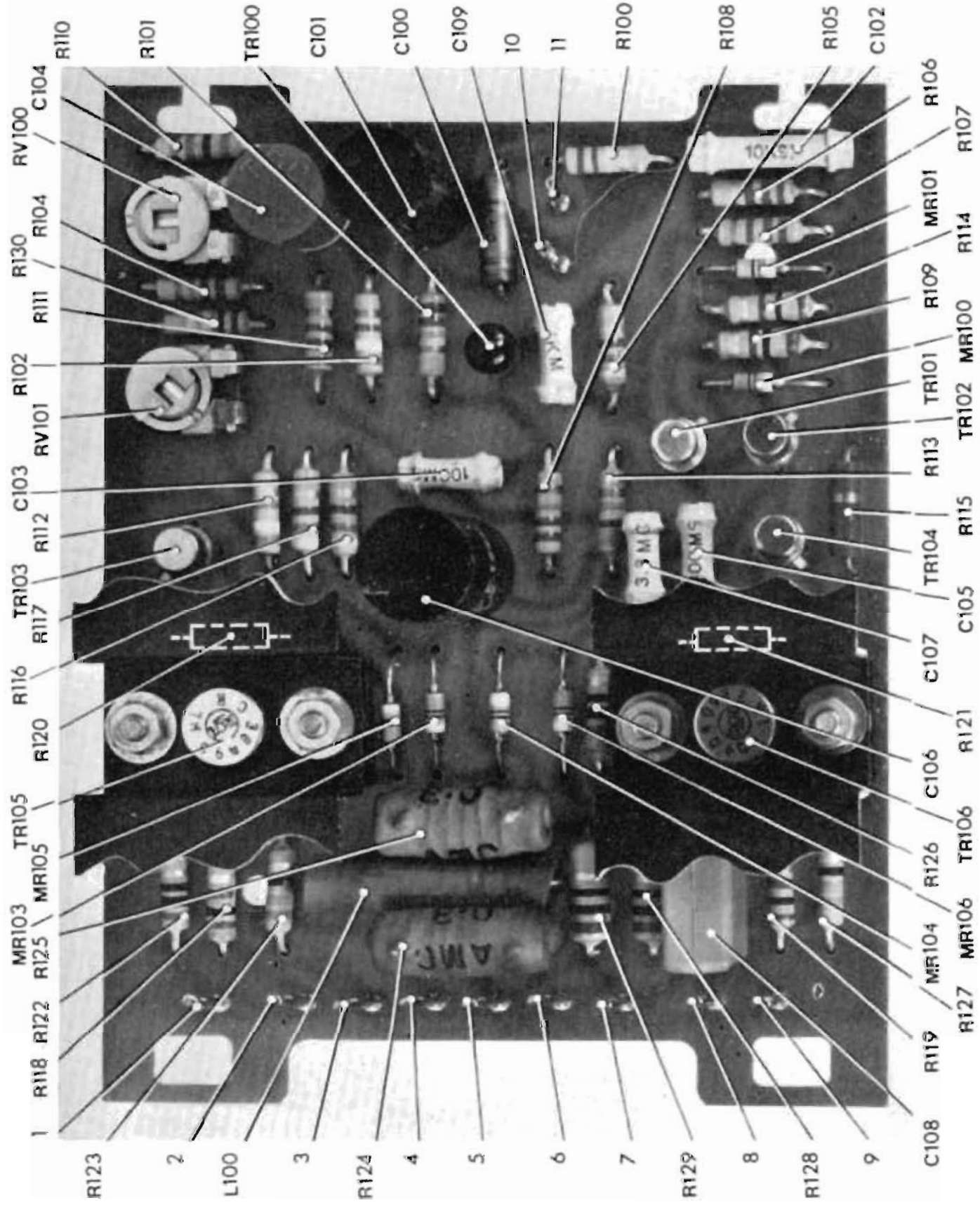

Fig. 11 (a) Driver Board M.12038 (issue 9)

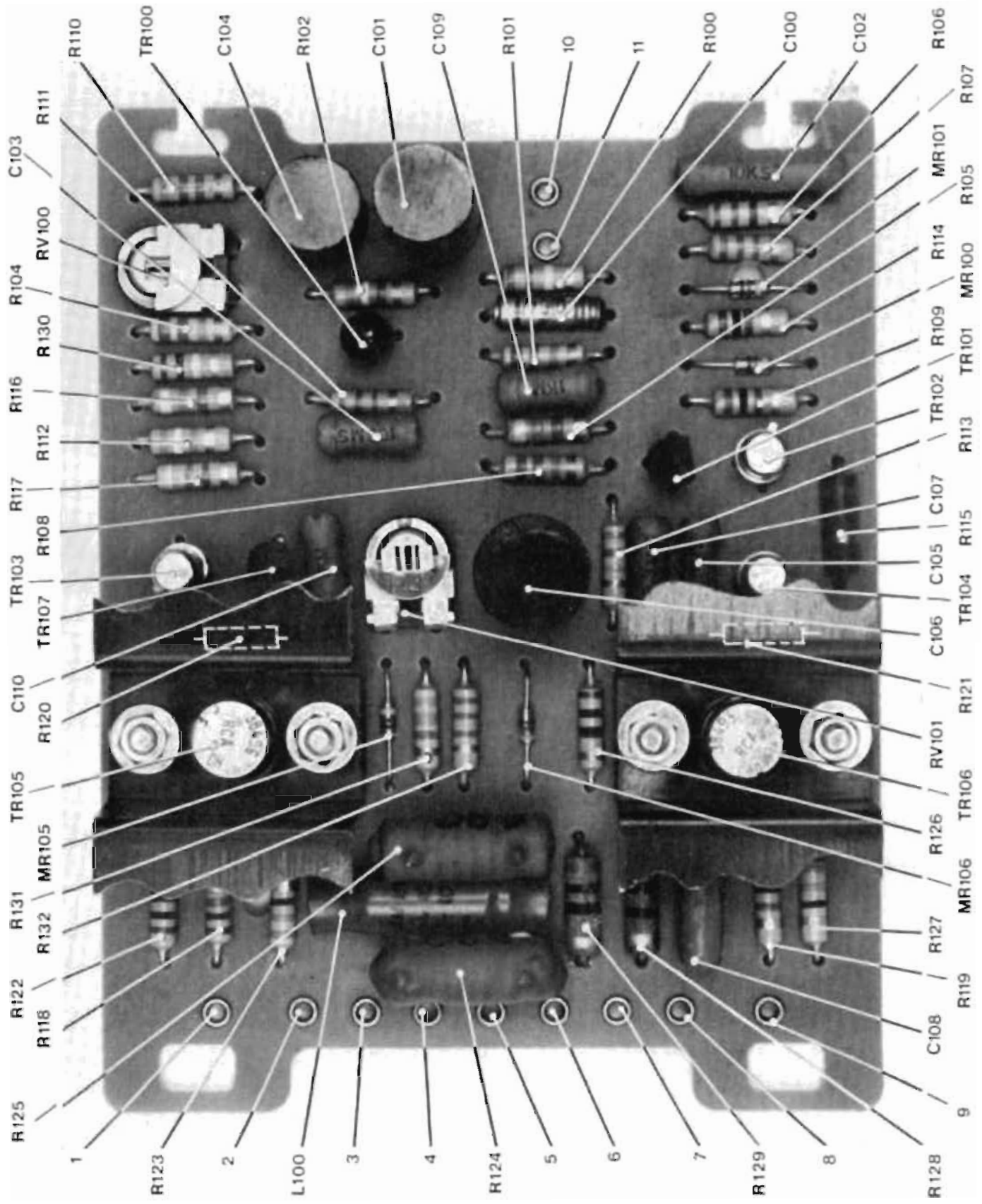

Fig. 11 (b) Driver Board M.12038 (issue 10)

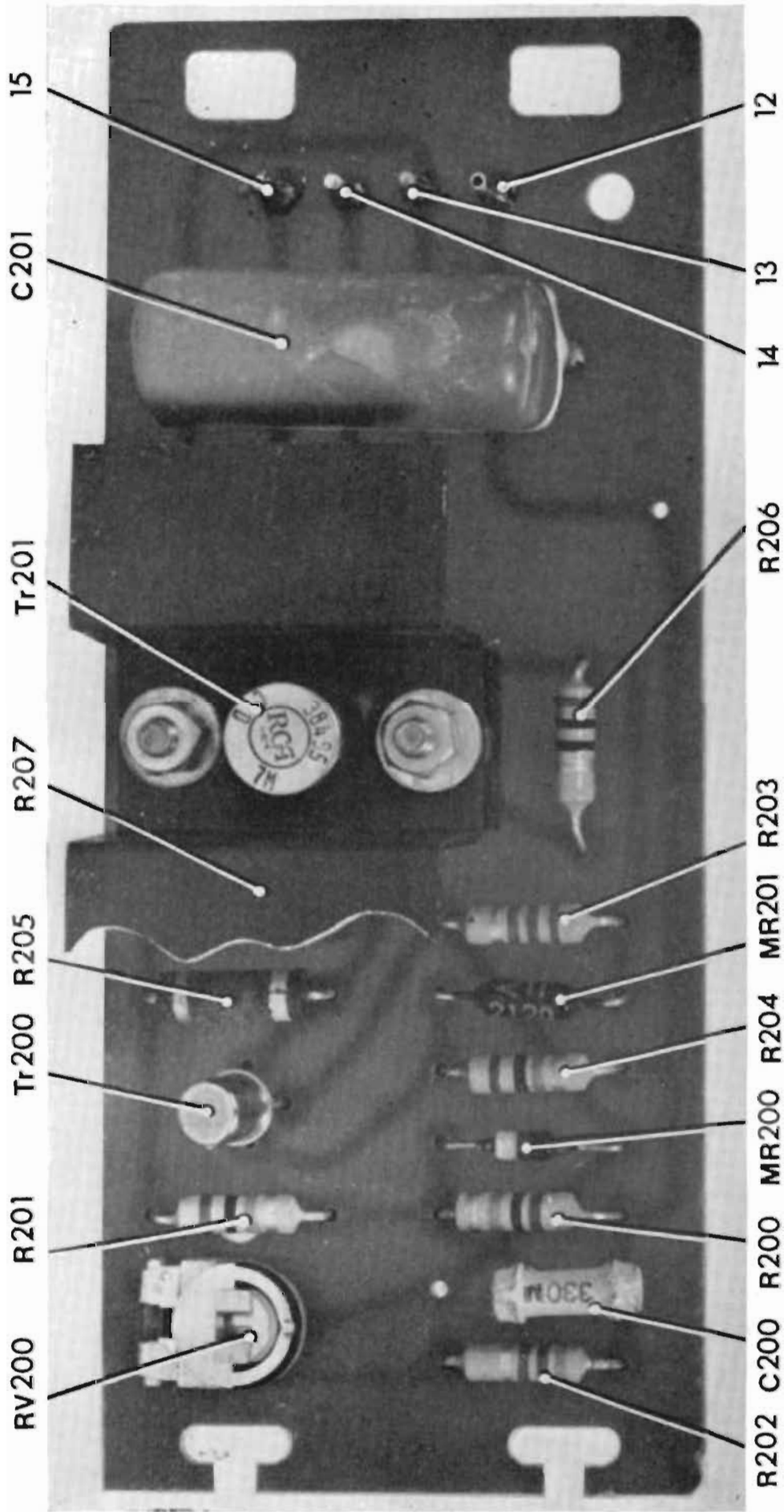

Fig. 12 Regulator Board M.12035

